

Description

The HTN7G38S007P is an unmatched discrete LDMOS Power Amplifier with 7W saturated output power covering frequency range from 700 - 3800 MHz.

Features

- Operating Frequency Range: 700 - 3800 MHz
- Operating Drain Voltage: +28V
- Saturation Output Power: 7W
- Power Average: 0.76W
- Excellent thermal stability due to low thermal resistance package
- Enhanced robustness design without device degradation
- Internally integrated enhanced ESD design

Applications

- CDMA
- W-CDMA
- GSM EDGE
- MC-GSM
- TDD/FDD LTE
- WiMAX

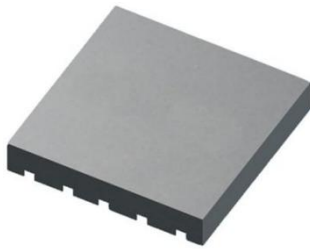

PDFN5X5 

Power Dual Flat pack No Lead

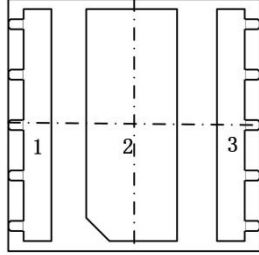

Bottom View
Terminal No.
1: Gate
2: Source
3: Drain

Note: Exposed backside of the package is the source terminal for the transistor

Pin Connections

Ordering Information

Part Number	Description
HTN7G38S007P	Reel Package
HTN7G38S007PEVB	2110 - 2170 MHz EVB
HTN7G38S007PEVB1	2620 - 2690 MHz EVB
HTN7G38S007PEVB2	3300 - 3400 MHz EVB

Typical Performance

RF Characteristics (CW)

Freq (MHz)	Gain (dB)	P1dB (dBm)	Eff (%)@ P1dB (dBm)	P3dB (dBm)	Eff (%)@ P3dB (dBm)
2110	19.4	38.9	55.1	39.5	56.2
2140	19.5	38.7	54.7	39.4	56.0
2170	19.3	38.6	53.6	39.4	55.1
3700	14.8	37.26	43.96	38.53	47.55
3800	15.3	36.40	41.04	38.27	47.21

Test conditions unless otherwise noted: 25 °C, VDD = +28Vdc, IDQ= 70mA test on WATECH Application Board

Freq (MHz)	Gain (dB)	P1dB (dBm)	Eff (%)@ P1dB (dBm)	P3dB (dBm)	Eff (%)@ P3dB (dBm)
3300	14.8	37.7	43.2	38.8	46.8
3350	14.5	37.5	43.6	38.7	47.6
3400	14.3	37.6	45.1	38.7	48.3

Test conditions unless otherwise noted: 25 °C, VDD = +28Vdc, IDQ= 80mA test on WATECH Application Board

RF Characteristics (Pulsed CW)

Freq (MHz)	Gain (dB)	P1dB (dBm)	Eff (%)@ P1dB (dBm)	P3dB (dBm)	Eff (%)@ P3dB (dBm)
3700	14.6	38.05	46.01	38.93	48.08
3800	15.2	37.47	46.11	38.69	48.33

Test conditions unless otherwise noted: 25 °C, VDD = +28Vdc, IDQ=70mA, PW = 100us, DC= 10% test on WATECH Application Board

RF Characteristics (WCDMA)

Freq (MHz)	Gain (dB)	Eff (%)	ACPR* @5MHz (dBc)	IRL (dB)
2110	19.2	19.2	-46.4	12
2140	19.3	19.2	-45.6	18
2170	19.1	18.7	-45.2	16

Test conditions unless otherwise noted: 25 °C, VDD = +28Vdc, IDQ= 100mA, PAVG = 28.8 dBm (0.76W), 1C-WCDMA 5MHz Signal, 9.9 dB PAR @ 0.01% CCDF test on WATECH Application Board

**Uncorrected DPD*



HTN7G38S007P

7W, 700 - 3800 MHz LDMOS Amplifier

Product datasheet

Freq (MHz)	Gain (dB)	Eff (%)	ACPR* @5MHz (dBc)	IRL (dB)
3300	14.8	16.4	-47.0	9.1
3350	14.4	17.0	-47.6	8.9
3400	14.2	17.4	-47.1	8.8

Test conditions unless otherwise noted: 25 °C, VDD = +28Vdc, IDQ= 80mA, PAVG = 28.8 dBm (0.76W), 1C-WCDMA 5MHz Signal, 9.9 dB PAR @ 0.01% CCDF test on WATECH Application Board

*Uncorrected DPD

Freq (MHz)	Gain (dB)	Eff (%)	ACPR* @5MHz (dBc)	IRL (dB)
3700	14.6	18.1	-44.4	11.8
3800	15.2	18.7	-43.0	11.4

Test conditions unless otherwise noted: 25 °C, VDD = +28Vdc, IDQ= 80mA, PAVG = 28.8 dBm (0.76W), 1C-WCDMA 5MHz Signal, 9.9 dB PAR @ 0.01% CCDF test on WATECH Application Board

*Uncorrected DPD

RF Characteristics (LTE)

Freq (MHz)	Gain (dB)	Eff (%)	ACPR (dBc)*	IRL (dB)
3310	14.8	17.2	-48.2	9.1
3350	14.4	17.7	-48.1	8.9
3390	14.2	18.1	-47.1	8.8

Test conditions unless otherwise noted: 25 °C, VDD = +12Vdc, IDQ= 80mA, PAVG = 28.8 dBm (0.76W), FDD LTE 20MHz DL Signal, 10 dB PAR @ 0.01% CCDF test on WATECH Application Board

*Uncorrected DPD

Freq (MHz)	Gain (dB)	Eff (%)	ACPR (dBc)*	IRL (dB)
3700	14.6	17.9	-42.2	11.8
3800	15.2	18.3	-41.0	11.4

Test conditions unless otherwise noted: 25 °C, VDD = +12Vdc, IDQ= 70mA, PAVG = 28.8 dBm (0.76W), FDD LTE 20MHz DL Signal, 10 dB PAR @ 0.01% CCDF test on WATECH Application Board

*Uncorrected DPD

Absolute Maximum Ratings

Parameter	Range/Value	Unit
Drain voltage (V_{DSS})	-0.5, +65	V
Gate voltage (V_{GS})	-5 to +10	V
Operation voltage (V_{DD})	+0 to +28	V
Storage Temperature (T_{STG})	-55 to +150	°C
Case Temperature (T_c)	-40 to +150	°C
Junction Temperature (T_J)	-40 to +225	°C

Electrical Specification

DC Characteristics

Parameter	Conditions	Min	Typ	Max	Unit
Breakdown Voltage $V_{(BR)DSS}$	$V_{GS}=0V, I_{DS}=8.4\mu A$	65	-	-	V
Gate-Source Threshold Voltage $V_{GS(th)}$	$V_{DS}=V_{GS}, I_{DS}=8.4\mu A$	-	1.4	-	V
Drain Leakage Current I_{DSS}	$V_{GS}=0V, V_{DS}=65V$	-	-	1.4	μA
Gate Leakage Current I_{GSS}	$V_{GS}=5V, V_{DS}=0V$	-	-	140	nA

Load Mismatch Test

Condition	Test Result
VSWR=10:1, at all Phase Angles, $V_{DD} = +28V_{dc}$, $I_{DQ} = 70mA$, CW signal $P_{out} = 40 dBm$ (3dB input Overdrive from P3dB) @2140 MHz test on WATECH Application Board	No Device Degradation

Thermal Information

Parameter	Condition	Value (Typ)	Unit
Thermal Resistance Junction to Case (R_{TH})	$T_{CASE} = 50^\circ C$, $V_{DD} = +28V_{dc}$, $I_{DQ} = 70mA$, CW signal 7W	2.9	°C /W

RF Characteristics (WCDMA)

Parameter	Conditions	Min	Typ.	Max	Unit
Frequency		2140			MHz
Gain	$P_{AVG} = 28.8dBm$	-	19.3	-	dB
Eff	$P_{AVG} = 28.8dBm$	-	19.2	-	%
ACPR@5MHz*	$P_{AVG} = 28.8dBm$	-	-45.6	-	dBc

Test conditions unless otherwise noted: 25 °C, $V_{DD} = +28V_{dc}$, $I_{DQ} = 70mA$, $P_{AVG} = 28.8 dBm$ (0.76W), 1C-WCDMA 5MHz Signal, 9.9 dB PAR @ 0.01% CCDF test on WATECH Application Board

*Uncorrected DPD, measured in 3.84MHz Channel Bandwidth @ $\pm 5MHz$ Offset



HTN7G38S007P

7W, 700 - 3800 MHz LDMOS Amplifier

Product datasheet

RF Characteristics (CW)

Parameter	Conditions	Min	Typ.	Max	Unit
P1dB	2140 MHz	-	38.9	-	dB
AM/PM (\emptyset)	2110-2170 MHz@P3dB	-	18.1	-	$^{\circ}$
VBWres	(IMD Third Order Inter modulation Inflection Point)	-	90	-	MHz
Gain Flatness	2110-2170 MHz@60 MHz	-	0.3	-	dB

Test conditions unless otherwise noted: 25 °C, VDD = +28Vdc, IDQ= 70mA test on WATECH Application Board

Load Pull Performance for Maximum Power (P1dB/P3dB)

Test conditions unless otherwise noted: 25 °C, VDD = +28Vdc, IDQ= 70mA, PW = 40us, DC= 4%

Max Output Power P1dB						
Freq (MHz)	Z_source (Ω)	Z_load [1] (Ω)	Gain (dB)	P1dB (dBm)	P1dB (W)	Eff (%)
920	1.40+j*8.88	33.21+j*2.89	24.89	41.02	12.65	62.60
1400	1.42+j*3.55	26.36+j*3.33	22.02	39.95	9.89	59.478
1800	0.81+j*2.15	17.20+j*5.22	21.36	39.86	9.68	58.36
2110	0.83-j*0.95	11.00+j*6.41	20.79	39.88	9.73	58.09
2300	0.95-j*2.25	10.12+j*7.20	20.17	39.52	8.95	54.08
2690	1.02-j*3.11	9.00+j*3.34	18.89	39.37	8.65	52.99
3400	2.52-j*6.89	6.82-j*1.04	15.88	38.89	7.74	49.02

[1] Load impedance for optimum P1dB pout

Max Output Power P3dB						
Freq (MHz)	Z_source (Ω)	Z_load [2] (Ω)	Gain (dB)	P3dB (dBm)	P3dB (W)	Eff (%)
920	1.40+j*8.88	32.23+j*2.82	24.95	41.84	15.28	65.65
1400	1.42+j*3.55	27.14+j*4.17	22.08	40.82	12.08	62.38
1800	0.81+j*2.15	15.16+j*6.23	21.80	40.82	12.11	61.47
2110	0.83-j*0.95	12.35+j*6.26	20.61	40.65	11.61	59.40



HTN7G38S007P

7W, 700 - 3800 MHz LDMOS Amplifier

Product datasheet

2300	0.95-j*2.25	11.73+j*6.54	19.82	40.37	10.89	54.23
2690	1.02-j*3.11	12.05+j*4.01	18.81	40.32	10.76	54.91
3400	2.52-j*6.89	7.14-j*1.44	16.02	39.82	9.59	49.12

[2] Load impedance for optimum P3dB pout

Load Pull Performance for Maximum Efficiency (P1dB/P3dB)

Test conditions unless otherwise noted: 25 °C, VDD = +28Vdc, IDQ= 70mA, PW = 40us, DC= 4%

Max Efficiency P1dB						
Freq (MHz)	Z_source (Ω)	Z_load [1] (Ω)	Gain (dB)	P1dB (dBm)	P1dB (W)	Eff (%)
920	1.40+j*8.88	18.64+j*32.81	27.42	38.41	6.93	73.88
1400	1.42+j*3.55	13.42+j*26.48	25.16	36.80	4.79	71.48
1800	0.81+j*2.15	6.01+j*16.72	24.94	36.25	4.22	69.48
2110	0.83-j*0.95	5.77+j*12.95	23.30	37.46	5.57	68.35
2300	0.95-j*2.25	5.26+j*11.98	22.27	37.52	5.65	61.92
2690	1.02-j*3.11	5.47+j*7.03	20.64	37.90	6.17	60.21
3400	2.52-j*6.89	3.96-j*0.85	16.62	38.34	6.82	51.06

[1] Load impedance for optimum P1dB efficiency

Max Efficiency P3dB						
Freq (MHz)	Z_source (Ω)	Z_load [2] (Ω)	Gain (dB)	P3dB (dBm)	P3dB (W)	Eff (%)
920	1.40+j*8.88	25.74+j*32.68	27.26	39.79	9.53	74.58
1400	1.42+j*3.55	13.71+j*25.47	25.29	38.30	6.76	72.12
1800	0.81+j*2.15	7.46+j*14.94	25.02	38.55	7.16	70.92
2110	0.83-j*0.95	5.51+j*12.69	23.36	38.15	6.53	69.55
2300	0.95-j*2.25	4.81+j*11.90	22.36	38.01	6.32	62.29

2690	$1.02-j*3.11$	$6.29+j*6.60$	20.35	39.10	8.13	60.54
3400	$2.52-j*6.89$	$4.11-j*0.97$	16.58	39.23	8.38	51.96

[2] Load impedance for optimum P3dB efficiency

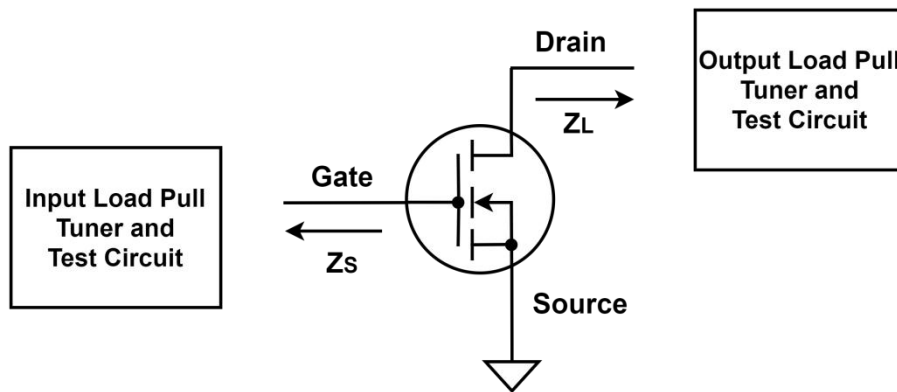

Z_{source} : Measured impedance presented to the input of the device at the package reference plane

Z_{load} : Measured impedance presented to the output of the device at the package reference plane

HTN7G38S007P 2110- 2170 MHz Reference Design

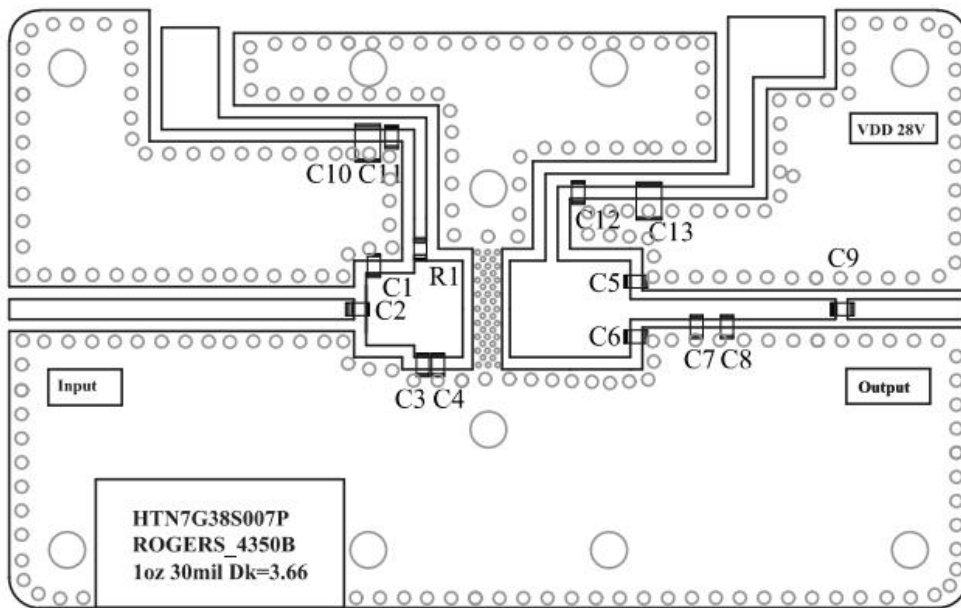

EVB Layout

Bill of Materials (BoM) - HTN7G38S007P 2110- 2170 MHz Reference Design

Reference	Value	Description	Manufacturer	P/N
Q1	-	20W, 700 - 3800 MHz LDMOS PA	Watech	HTN7G38S007P



HTN7G38S007P

7W, 700 - 3800 MHz LDMOS Amplifier

Product datasheet

C1	0p3F	MLCC	ATC	600S0R3BT260XT
C2,C9,C11,C12	8p2F	MLCC	ATC	600S8R2BT260XT
C3	2p2F	MLCC	ATC	600S2R2BT260XT
C4	1pF	MLCC	ATC	600S1R0BT260XT
C5	3pF	MLCC	ATC	600S3R0BT260XT
C6	1p5F	MLCC	ATC	600S1R5BT260XT
C7	1p8F	MLCC	ATC	600S1R8BT260XT
C8	1p2F	MLCC	ATC	600S1R2BT260XT
C10,C13	10uF/50V	MLCC	-	1210
R1	10Ω/0603	Thick Film Resistor	-	-
PCB	Rogers4350B (er = 3.66), 20 mil (0.508 mm), 35 μm (1oz)			

Performance Plots 2110- 2170 MHz Reference Design

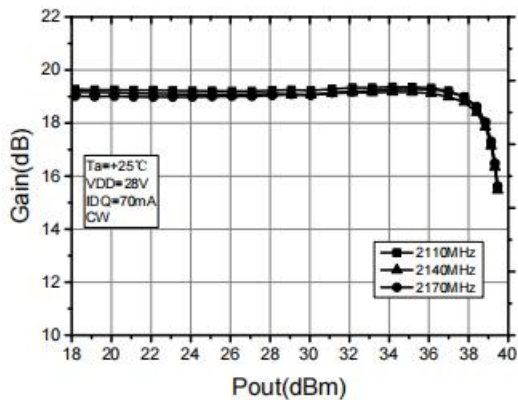

CW, Gain vs Pout

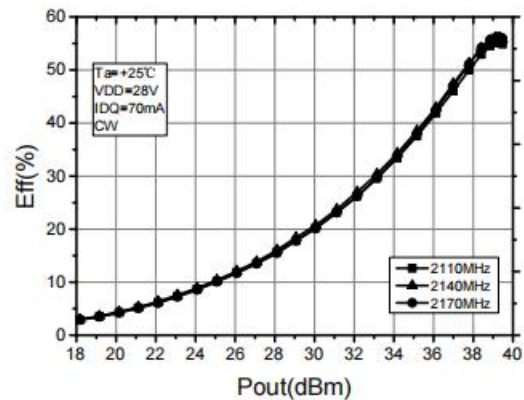

CW, Efficiency vs Pout

Test conditions unless otherwise noted: 25 °C, VDD = +28Vdc, IDQ=70mA test on WATECH Application Board



HTN7G38S007P

7W, 700 - 3800 MHz LDMOS Amplifier

Product datasheet

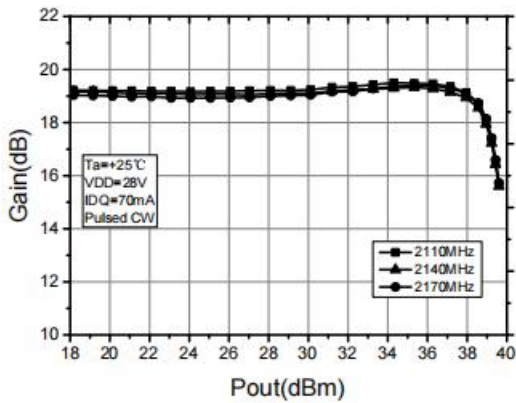

Pulsed CW, Gain vs Pout

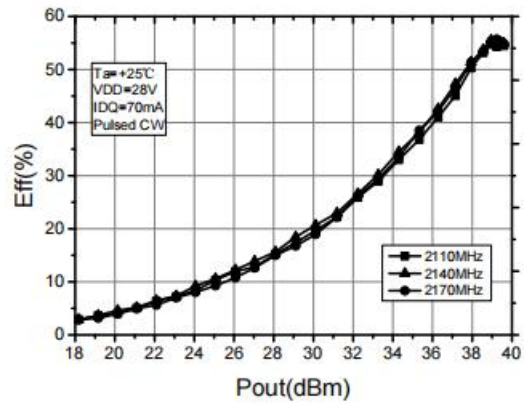

Pulsed CW, Efficiency vs Pout

Test conditions unless otherwise noted: 25 °C, VDD = +28Vdc, IDQ= 70mA, PW = 100us, DC= 10% test on WATECH Application Board

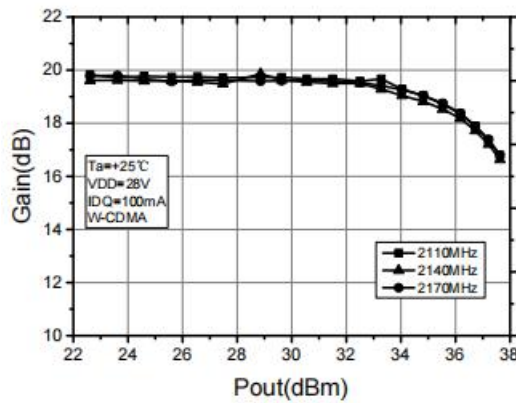

WCDMA, Gain vs Pout

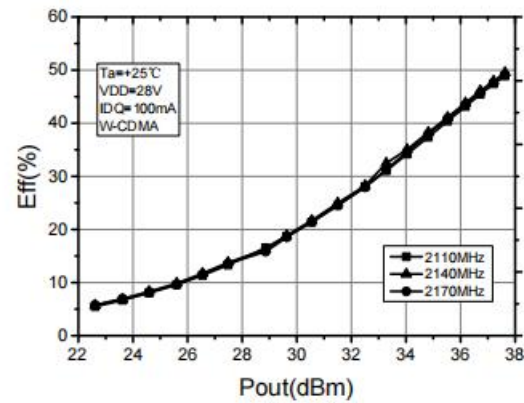

WCDMA, Efficiency vs Pout

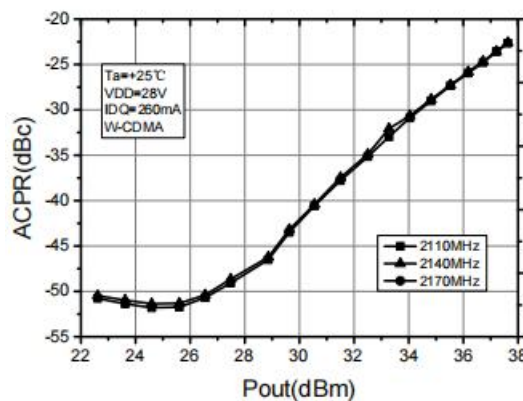

WCDMA ACPR_5MHz vs Pout

Test conditions unless otherwise noted: 25 °C, VDD = +28Vdc, IDQ= 70mA, 1C-WCDMA 5MHz Signal, 9.9 dB PAR @ 0.01% CCDF test on WATECH Application Board

HTN7G38S007P 2620- 2690 MHz Reference Design

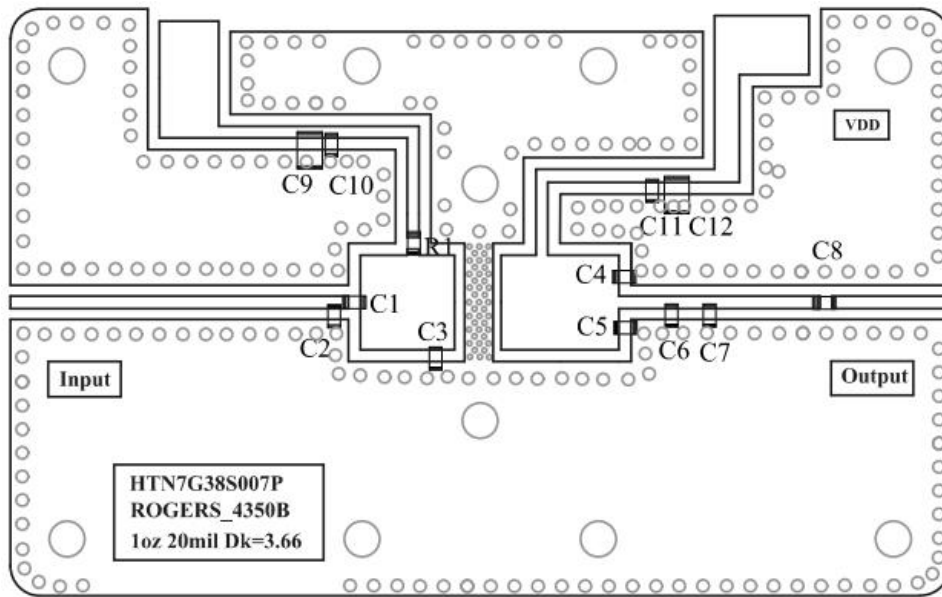

EVB Layout

Bill of Materials (BoM) - HTN7G38S007P 2620- 2690 MHz Reference Design

Reference	Value	Description	Manufacturer	P/N
Q1	-	20W, 700 - 3800 MHz LDMOS PA	Watech	HTN7G38S007P
C1	2p2F	MLCC	ATC	600S2R2BT260XT
C2	0p8F	MLCC	ATC	600S0R8BT260XT
C3	0p3F	MLCC	ATC	600S0R3BT260XT
C4	3pF	MLCC	ATC	600S3R0BT260XT
C5	0p5F	MLCC	ATC	600S0R5BT260XT
C6	1p8F	MLCC	ATC	600S1R8BT260XT
C7	0p8F	MLCC	ATC	600S0R8BT260XT
C8, C10, C11	5p6F	MLCC	ATC	600S5R6BT260XT
C9,C12	10uF/50V	MLCC	-	1210
R1	10Ω/0603	Thick Film Resistor	-	-
PCB	Rogers4350B (er = 3.66), 20 mil (0.508 mm), 35 μm (1oz)			

Performance Plots 2620- 2690 MHz Reference Design

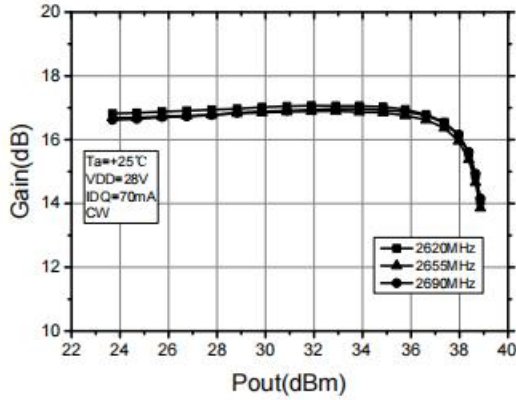

CW, Gain vs Pout

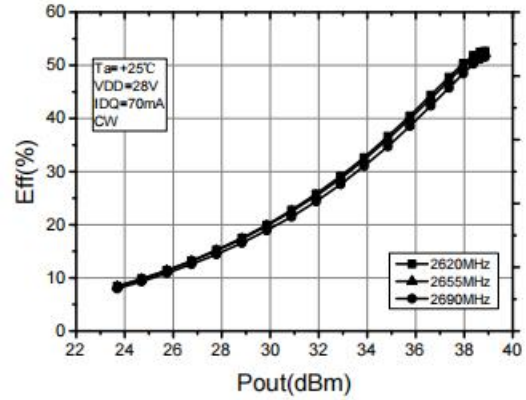

CW, Efficiency vs Pout

Test conditions unless otherwise noted: 25 °C, VDD = +28Vdc, IDQ=70mA test on WATECH Application Board

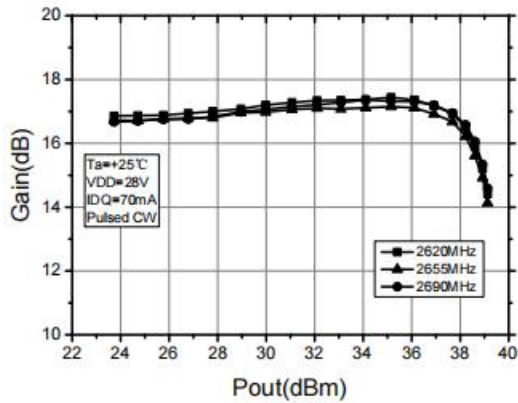

Pulsed CW, Gain vs Pout

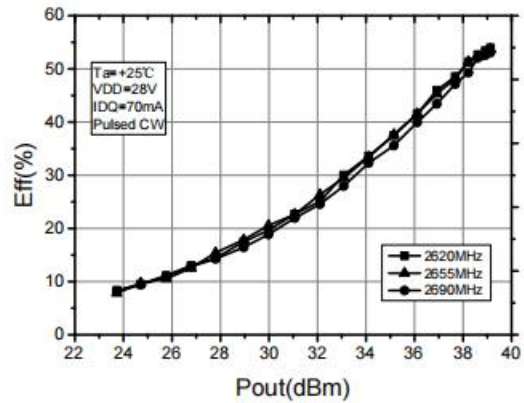

Pulsed CW, Efficiency vs Pout

Test conditions unless otherwise noted: 25 °C, VDD = +28Vdc, IDQ= 70mA, PW = 100us, DC= 10% test on WATECH Application Board

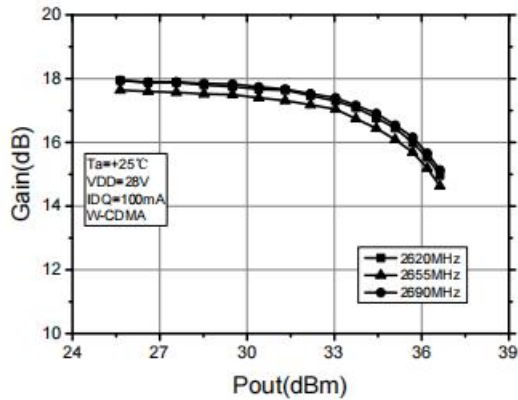

WCDMA, Gain vs Pout

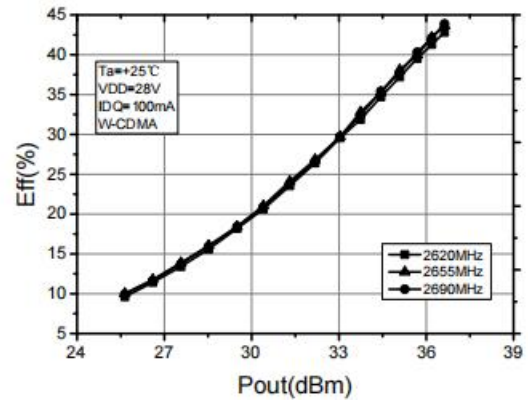

WCDMA, Efficiency vs Pout

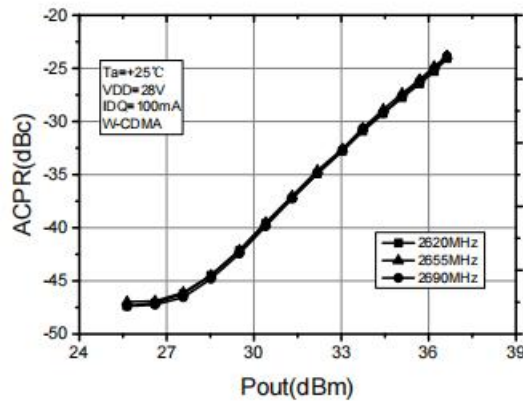

WCDMA ACPR_5MHz vs Pout

Test conditions unless otherwise noted: 25 °C, VDD = +28Vdc, IDQ= 70mA, 1C-WCDMA 5MHz Signal, 9.9 dB PAR @ 0.01% CCDF test on WATECH Application Board

HTN7G38S007P 3300- 3400 MHz Reference Design

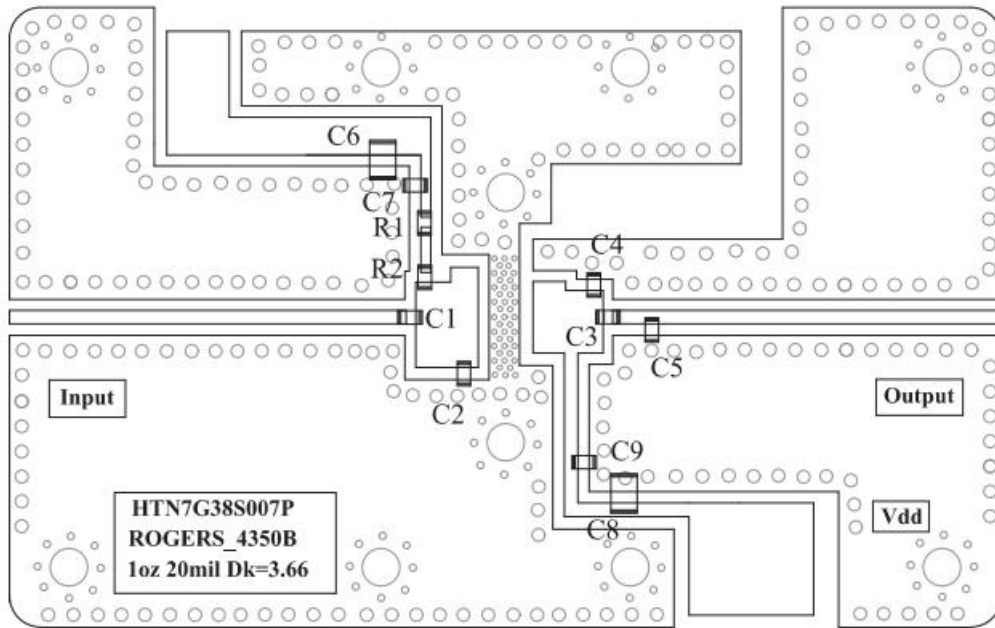

EVB Layout

Bill of Materials (BoM) - HTN7G38S007P 3300- 3400 MHz Reference Design

Reference	Value	Description	Manufacturer	P/N
Q1	-	20W, 700 - 3800 MHz LDMOS PA	Watech	HTN7G38S007P
C1, C3, C7, C9	0p3F	MLCC	ATC	600S0R3BT260XT
C2, C5	8p2F	MLCC	ATC	600S8R2BT260XT
C4	1pF	MLCC	ATC	600S1R0BT260XT
C6, C8	10uF/50V	MLCC	-	1210
R1, R2	4.7Ω/0603	Thick Film Resistor	-	-
PCB	Rogers4350B (er = 3.66), 20 mil (0.508 mm), 35 μm (1oz)			

Performance Plots 3300- 3400 MHz Reference Design

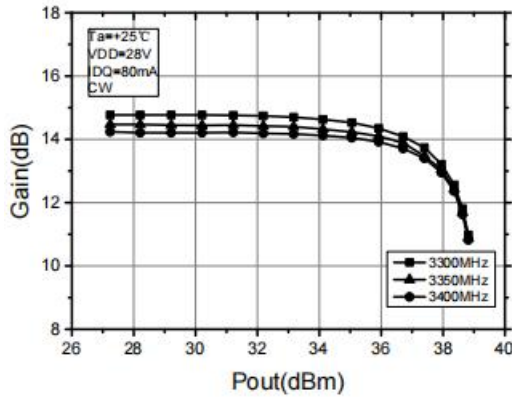

CW, Gain vs Pout

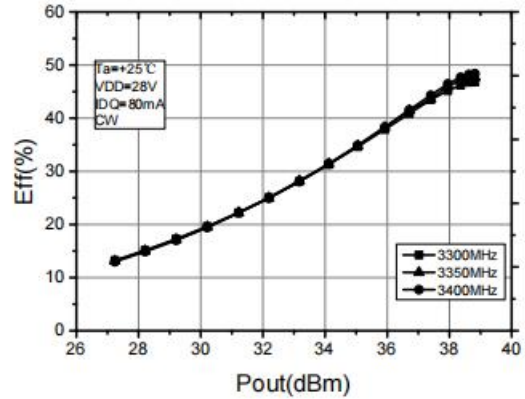

CW, Efficiency vs Pout

Test conditions unless otherwise noted: 25 °C, VDD = +28Vdc, IDQ=70mA test on WATECH Application Board

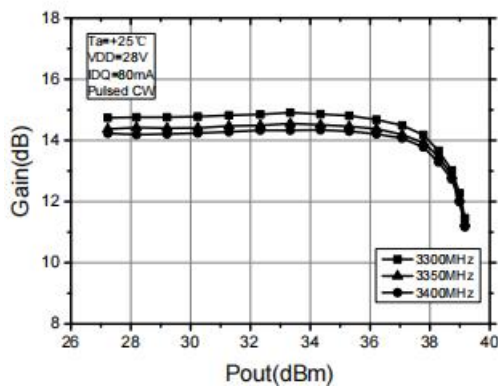

Pulsed CW, Gain vs Pout

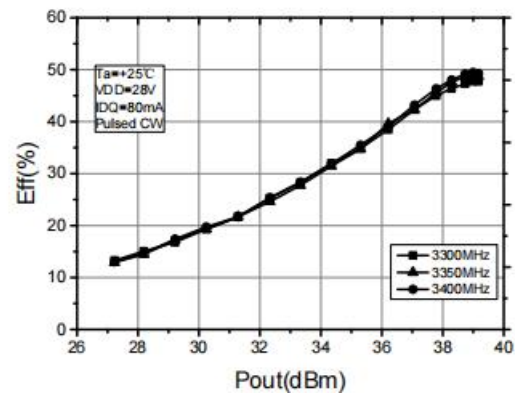

Pulsed CW, Efficiency vs Pout

Test conditions unless otherwise noted: 25 °C, VDD = +28Vdc, IDQ= 70mA, PW = 100us, DC= 10% test on WATECH Application Board

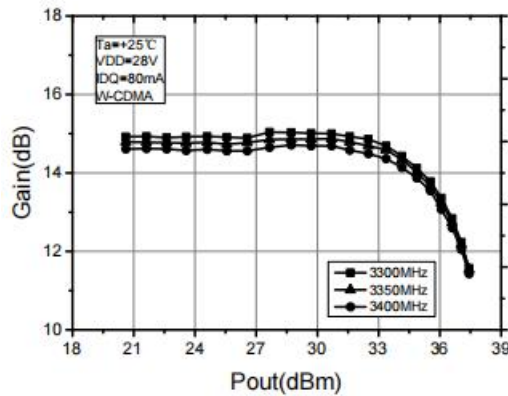

WCDMA, Gain vs Pout

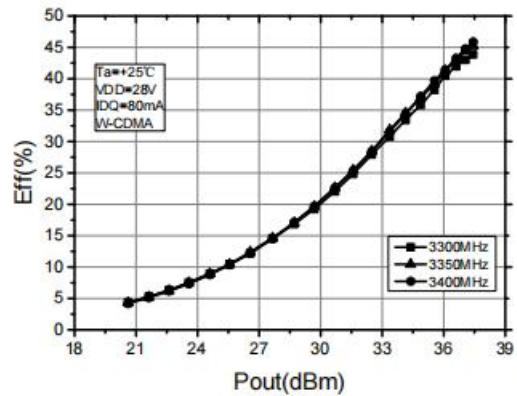

WCDMA, Efficiency vs Pout

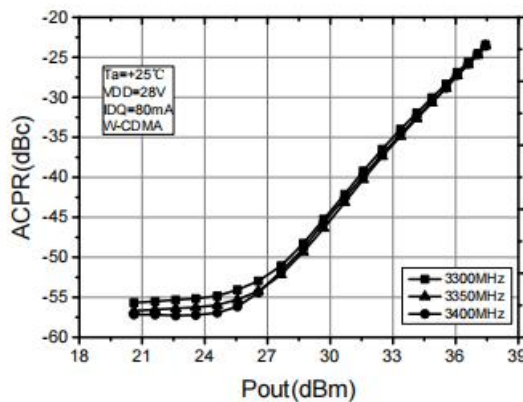

WCDMA ACPR_5MHz vs Pout

Test conditions unless otherwise noted: 25 °C, VDD = +28Vdc, IDQ = 70mA, 1C-WCDMA 5MHz Signal, 9.9 dB PAR @ 0.01% CCDF test on WATECH Application Board

Package Marking and Dimensions



- Line1 (fixed): Device name in W/O
- Line2 (unfixed): Marking Lot No in W/O (Sample: E596-20140001)
- Line3 (unfixed): Date Code + JY

This Marking SPEC only stipulates the content of Marking. For marking requirements such as font and size, please refer to the latest version of "Watech Product Printing Specification"

Marking

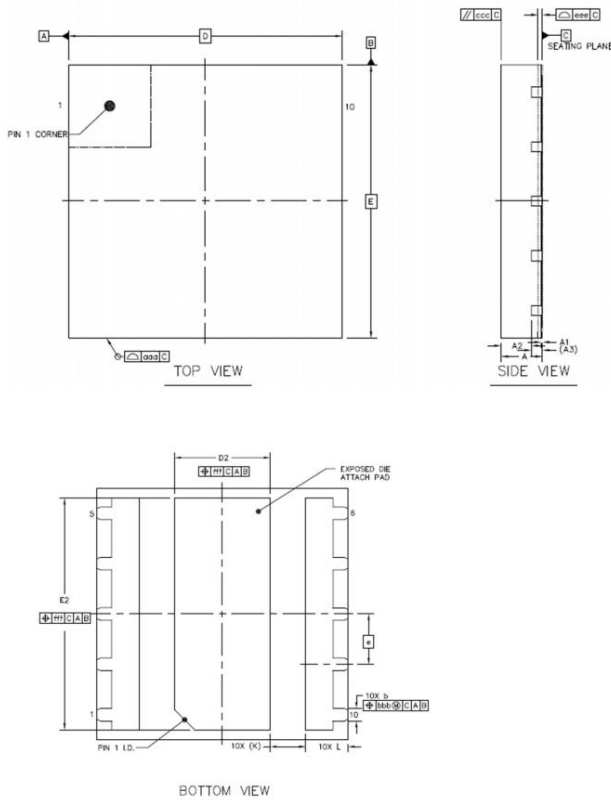

	SYMBOL	MIN	NOM	MAX
TOTAL THICKNESS	A	0.7	0.75	0.8
STAND OFF	A1	0	0.02	0.05
MOLD THICKNESS	A2	---	0.55	---
L/F THICKNESS	A3	0.203 REF		
LEAD WIDTH	b	0.2	0.25	0.3
BODY SIZE	X	D		
	Y	E		
LEAD PITCH	e	1 BSC		
EP SIZE	X	D2	1.8	1.9
	Y	E2	4.5	4.6
LEAD LENGTH	L	0.75	0.85	0.95
LEAD TIP TO EXPOSED PAD EDGE	K	0.7 REF		
PACKAGE EDGE TOLERANCE	aaa	0.1		
MOLD FLATNESS	ccc	0.1		
COPLANARITY	eee	0.08		
LEAD OFFSET	bbb	0.1		
EXPOSED PAD OFFSET	fff	0.1		

Package Dimensions

Tape and Reel Information

Package Type	Reel Size(inch)	Qty/Reel(pcs)	Qty/Box(pcs)	Qty/Carton(pcs)
PDFN5X5	7inch	1000	8000	32000

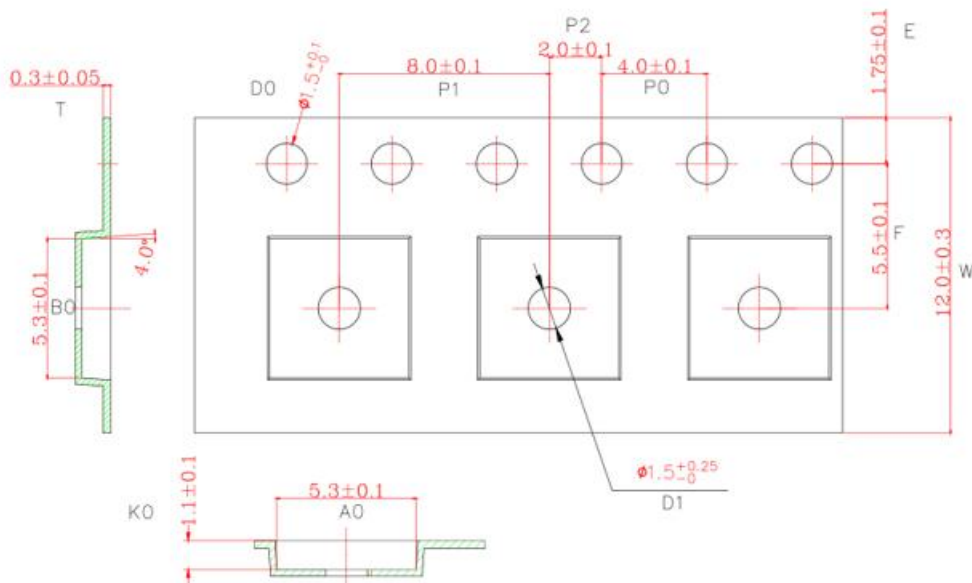

Tape & Reel Packaging Descriptions

Handling Precautions

Parameter	Grade
Moisture Sensitivity Level MSL	3

Parameter	Rating	Standard	
ESD – Human Body Model (HBM)	Class 1B	JESD22-A114	
ESD – Human Body Model (MM)	Class A	EIA/JESD22-A115	
ESD – Charged Device Model (CDM)	Class III	JESD22-C101	

RoHS Compliance

This product is compliant with the 2011/65/EU RoHS directive (Restrictions on the Use of Certain Hazardous Substances in Electrical and Electronic Equipment), as amended by Directive 2015/863/EU.

Datasheet Status

Document status	Product status	Definition
Objective Datasheet	Design simulation	Product objective specification
Preliminary Datasheet	Customer sample	Engineering samples and first test results
Product Datasheet	Mass production	Final product specification

Abbreviations

Acronym	Definition
LDMOS	Laterally-Diffused Metal-Oxide Semiconductor
CW	Continuous Waveform

Revision history

Document ID	Datasheet Status	Release Date	Revision Version
Rev 2.4	Product	April 2021	Corrected the operating junction temperature
Rev 2.5	Product	March 2023	New format based on English version datasheet
Rev 2.6	Product	April 2024	Update TBD information



HTN7G38S007P

7W, 700 - 3800 MHz LDMOS Amplifier

Product datasheet

Contact Information

For the latest specifications, additional product information, worldwide sales and distribution locations and information about WATECH:

- Web: www.watechelectronics.com
- Email: MKT@huatai-elec.com

For technical questions and application information:

- Email: MKT@huatai-elec.com

Important Notice

Information in this document is believed to be accurate and reliable. However, WATECH does not give any representations or warranties, expressed or implied, as to the accuracy or completeness of such information and shall have no liability for the consequences of use of such information.

“Typical” parameters are the average values expected by WATECH in large quantities and are provided for information purposes only. All information and specifications contained herein are subject to change without notice and customers should obtain and verify the latest relevant information before placing orders for WATECH products.

The information contained herein or any use of such information does not grant, explicitly or implicitly, to any party any patent rights, licenses, or any other intellectual property rights, whether with regard to such information itself or anything described by such information.

Applications that are described herein for any of these products are for illustrative purposes only. WATECH makes no representation or warranty that such applications will be suitable for the specified use without further testing or modification. Customers are responsible for the design and operation of their applications and products using WATECH products, and WATECH accepts no liability for any assistance with applications or customer product design. It is customer's sole responsibility to determine whether the WATECH product is suitable and fit for the customer's applications and products planned, as well as for the planned application and use of customer's third-party customer(s). Customers should provide appropriate design and operating safeguards to minimize the risks associated with their applications and products.

WATECH products are not designed, authorized or warranted to be suitable for use in life support, life-critical or safety-critical systems or equipment, nor in applications where failure or malfunction of a WATECH product can reasonably be expected to result in personal injury, death or severe property or environmental damage. This document as well as the item(s) described herein may be subject to export control regulations. Export might require a prior authorization from competent authorities.